

DC-ATCO

Direct Current Thermal-Link (Alloy Type)

ADNxxxB Series

Description

The Direct Current Thermal-Link Alloy Type (DC-ATCO) is a thermal-link that utilizes low melting point alloys, known as the thermal element, which fuse when heated to a specific fusing temperature. This allows for controlled circuit disconnection. The DC-ATCO is composed of various components, including a case, flux resin, the low melting point alloys (thermal element), electrode and inner shell.

The DC-ATCO is widely employed for over-temperature protection in electrical equipment and electric vehicles. Typically, the low melting point alloys (thermal element) are connected in series between two electrode pins. When the temperature reaches the predetermined fusing temperature of the DC-ATCO, the low melting point alloys (thermal element) melt and swiftly retract to the ends of the two pins, facilitated by the flux resin. This effectively disconnects the circuit.

The SETsafe | SETfuse Direct Current Thermal-Link (Alloy Type) is available in axial and radial shapes, with a rated functioning temperature ranging from 205 °C to 230 °C, rated current: 50 A, 55 A, 80 A, rated voltage: 48 VDC. It is compliant with RoHS and REACH regulations.



Marking

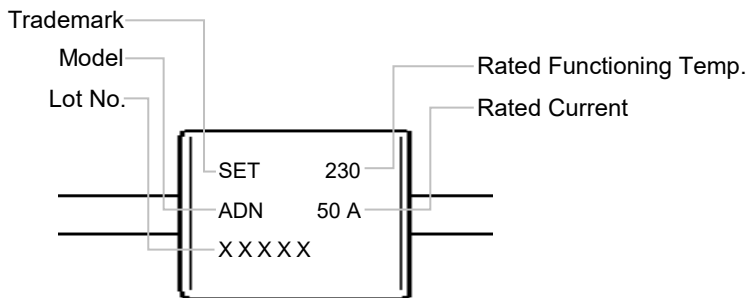

Structure Diagram

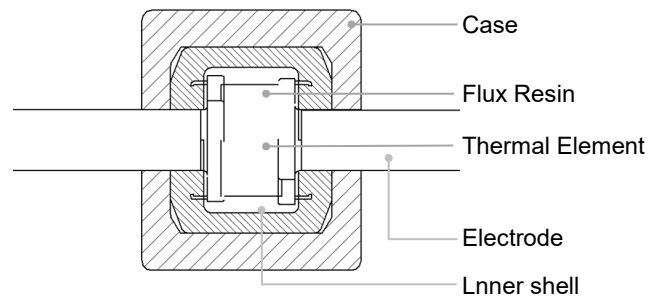

Features

- High Accuracy of Functioning Temp.
- Non-Resettable
- RoHS & REACH Compliant

Applications

- Steam mop
- ABS
- Motors

Customization

- Rated Functioning Temp.

DC-ATCO

Direct Current Thermal-Link (Alloy Type)

ADNxxxB Series

Part Number System

ADN230B - N D Z

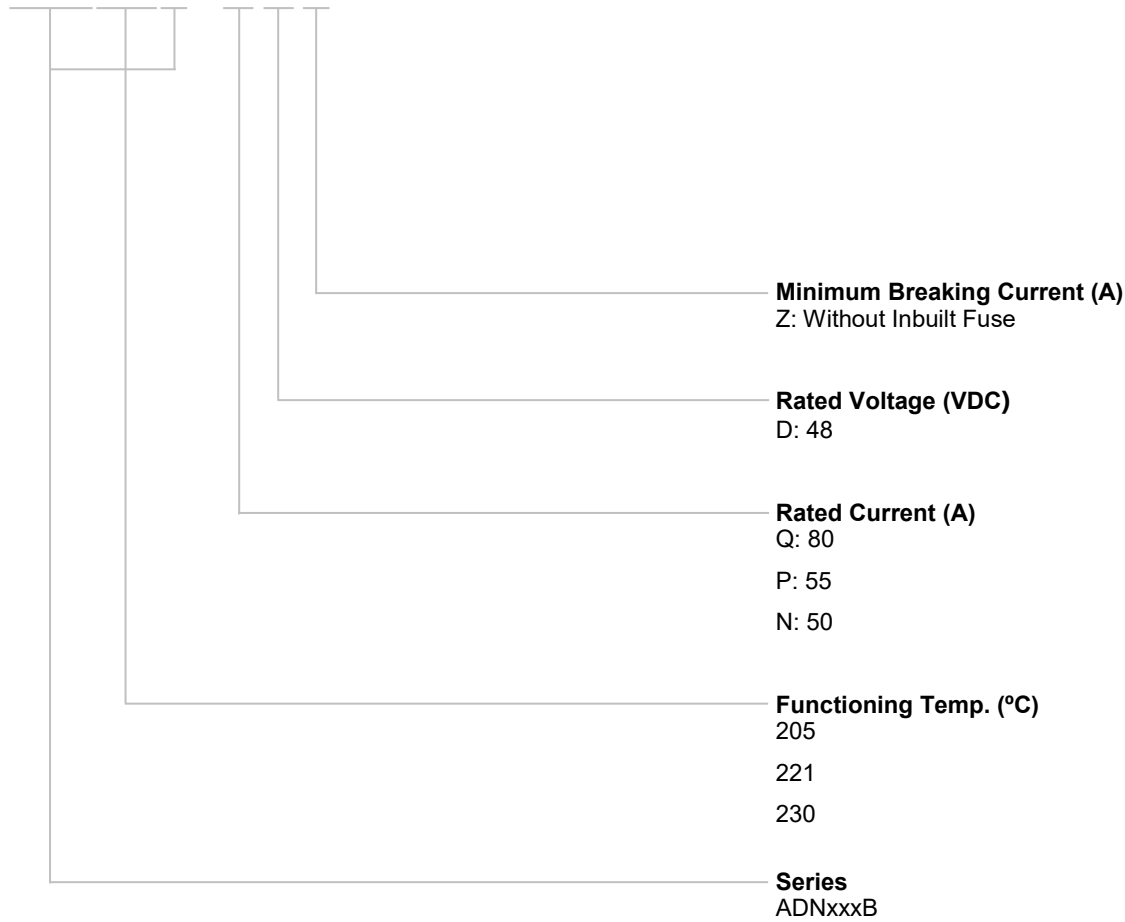

Reminder:

Part numbering system in the datasheet is only for selecting correct parameter and product features. Before placing order, please contact us for specifications and use the part number and product code in the specifications to place order to ensure the part is correct. Product code is the unique identification.

DC-ATCO
Direct Current Thermal-Link (Alloy Type)

ADNxxxB Series

Dimensions (Unit: mm)

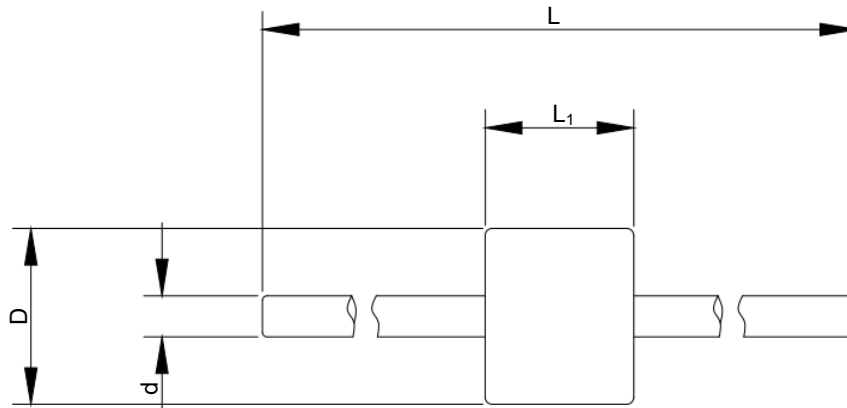

L	L ₁	D	d
6.5 ± 0.3	26.0 ± 0.5	Φ7.7 ± 0.2	Φ1.8 ± 0.1

Specifications

Rated Functioning Temp. (T _f) °C	Model	I _r	U _r	Rated Functioning Temp.	T _h	T _m	RoHS REACH
		(A)	DC (V)	(°C)	(°C)	(°C)	
230	ADN230B-NDZ	50	48	230 ± 10	160	260	●
	ADN230B-PDZ	55					●
	ADN230B-QDZ	80					●
221	ADN221B-NDZ	50	48	221 ± 10	160	260	●
	ADN221B-PDZ	55					●
	ADN221B-QDZ	80					●
205	ADN205B-NDZ	50	48	205 ± 10	160	260	●
	ADN205B-PDZ	55					●
	ADN205B-QDZ	80					●

Note:
1. RoHS & REACH Comply.

Temp.-Time Curve

The functioning temperature time curve of Alloy Thermal-Link in different Temp. oil bath (For reference only).

Come as soon as possible

Current-Time Curve

This is an illustrated curve, describing the opening time at Multi-times rated current in the condition of the room Temp. 25 °C (For reference only).

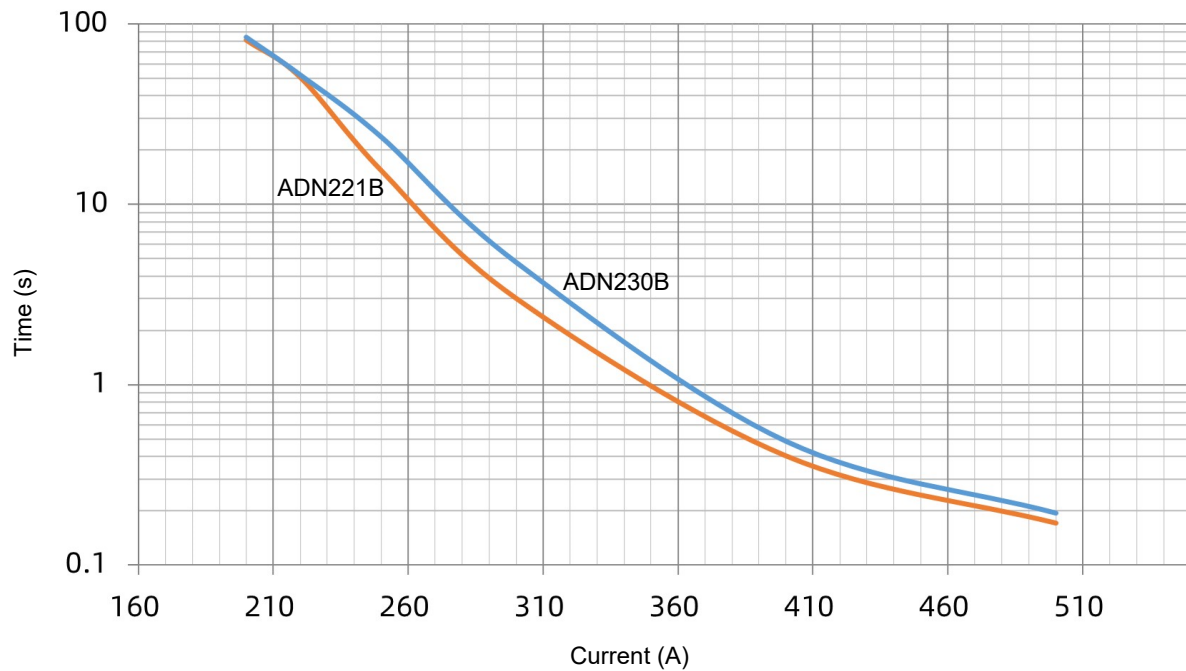

Packaging Information

Item	PE Bag	Box	Carton
Dimensions (mm)	138 x 86	222 x 100 x 80	314 x 239 x 100
Quantity (PCS)	100	600	1800
Gross Weight (kg)			3 ± 10%

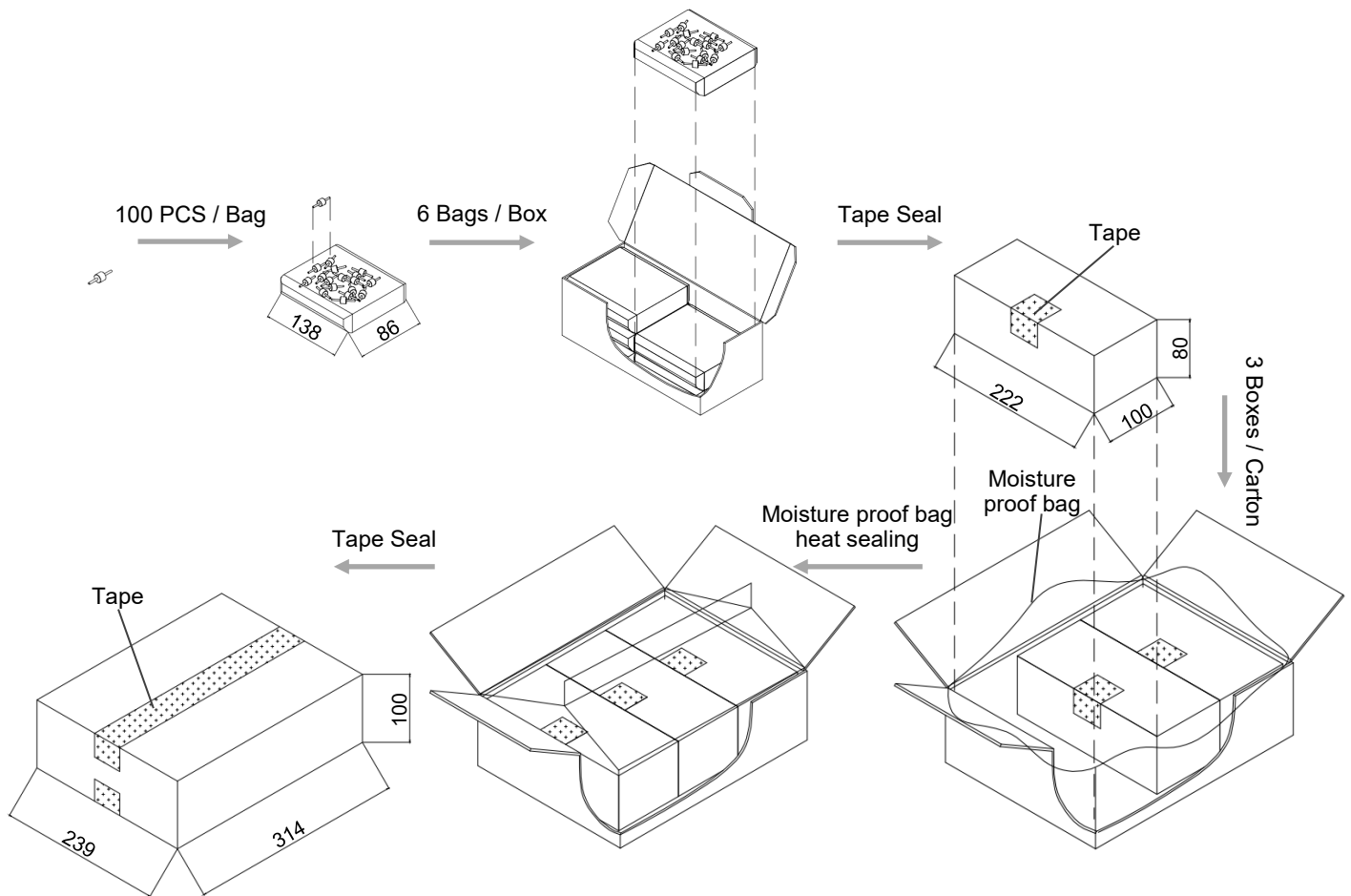

Glossary

Item	Description
DC-ATCO	DC-Alloy Thermal-Link DC-Alloy type Thermal-Link, Alloy is thermal element.
T_f	Rated Functioning Temp. The temperature of the Thermal-Link which causes it to change the state of conductivity with a detection current up to 10 mA as the only load. Tolerance: T_f (0 / -10) °C (GB 9816, EN 60691, K60691). Tolerance: $T_f \pm 7$ °C (J60691).
Fusing Temp.	Fusing Temp. The temperature of the Alloy Thermal-Link which causes it to change its state of conductivity is measured with silicone oil bath in which the temperature is increased at the rate of 0.5 °C to 1 °C / minute, with a detection current up to 10 mA as the only load.
T_h	Holding Temp. The Maximum temperature at which a Thermal-Link will not change its state of conductivity when conducting rated current for 168 hours.
T_m	Maximum Temp. Limit The temperature of the Thermal-Link stated by the manufacturer, up to which the mechanical and electrical properties of the Thermal-Link having changed its state of conductivity, will not be impaired for a given time.
I_{min}	Minimum Breaking Current The minimum current that Fuse requires after the Alloy of Thermal-Link opens in the circuit.
I_r	Rated Current The current used to classify a Thermal-Link, which is the maximum current that Thermal-Link allows to carry and is able to cut off the circuit safely.
U_r	Rated Voltage The voltage used to classify a Thermal-Link, which is the maximum voltage that Thermal-link allows to carry and is able to cut off the circuit safely.



ATTENTION

Usage

1. When atmosphere pressure is from 80 kPa to 106 kPa, the related altitude shall be from –500 m to 2000 m.
2. Operating voltage less than rated voltage of DC-ATCO, operating current less than rated current of DC-ATCO.
3. Do not touch the DC-ATCO body or lead wires directly when power is on, to avoid burn or electric shock.

Replacement

DC-ATCO is a non-repairable product. For safety sake, it shall be replaced by an equivalent DC-ATCO from the same manufacturer, and mounted in the same way.

Storage

Do not store the DC-ATCO at the high temp., high humidity or corrosive gas environment. The product shall be stored at 25 ± 5 °C and $\leq 70\%$ RH, avoid direct sunlight and shall use them up within 1 year after receiving the goods.

Installation

Make Sure the Temp. of Installation Position

1. It is recommended that a dummy DC-ATCO with inbuilt thermo-couple shall be used to determine the proper temp.
2. The terminal product should be tested to ensure that potential abnormal conditions do not cause ambient temp. to exceed the T_m of the DC-ATCO.
3. Mount the DC-ATCO at the location where temp. rises evenly.

Installation position of mechanical performance requirements









1. Ensure that the lead wire is long enough, and avoid actions such as press, tensile or twist.
2. The seal or body of DC-ATCO must not be damaged, burned or over heated.

Mechanical Connection



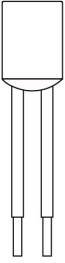

Riveting

1. Choose small resistivity riveting material and be riveted.
2. A flexible lead or lead with low resistance should be used to rivet the DC-ATCO.
3. Contact resistance should be minimal, Large contact resistance will lead to higher temp., DC-ATCO Functioning in advance.

Direct Current Thermal-Link Alloy Type (DC-ATCO) Features & Model List Overview

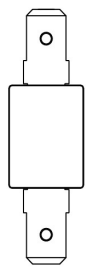
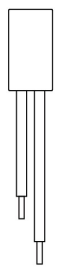
Rated Functioning Temp. (T _r) °C	Model								
	TGH187-HVS [^]	ASL187A-LSF [^]	RSK187A-KSS [^]	RVH187-HSF [^]	ARL187-LRA [^]			RQF187-FQS [^]	
230	○	○	○	○	○	○	○	○	○
221	○	○	○	○	○	○	○	○	○
205	○	○	○	○	○	○	○	○	○
200	○	○	○	○	○	○	○	○	○
187	TGH187-HVS [^]	ASL187A-LSF [^]	RSK187A-KSS [^]	RVH187-HSF [^]	ARL187-LRA [^]	○	○	RQF187-FQS [^]	○
160	○	○	○	○	○	○	○	○	○
150	TGH150-HVS [^]	ASL150A-LSF [^]	RSK150A-KSS [^]	RVH150-HSF [^]	ARL150-LRA [^]	RPK150-HRZ [^]	TG150C-HQZ [^]	RQF150-FQS [^]	TG150C-JPZ [^]
145	○	○	○	○	○	○	○	○	○
139	○	○	○	○	○	○	○	○	○
136	TGH136-HVS [^]	ASL136A-LSF [^]	RSK136A-KSS [^]	RVH136-HSF [^]	ARL136-LRA [^]	RPK136-HRZ [^]	TG136C-HQZ [^]	RQF136-FQS [^]	TG136C-JPZ [^]
135	○	○	○	○	○	○	○	○	○
133	○	○	○	○	○	○	○	○	○
130	TGH130-HVS [^]	○	○	RVH130-HSF [^]	○	○	○	RQF130-FQS [^]	○
125	TGH125-HVS [^]	ASL125A-LSF [^]	RSK125A-KSS [^]	RVH125-HSF [^]	ARL125-LRA [^]	RPK125-HRZ [^]	TG125C-HQZ [^]	RQF125-FQS [^]	TG125C-JPZ [^]
123	○	○	○	○	○	○	○	○	○
120	○	○	○	○	○	○	○	○	○
115	TGH115-HVS [^]	ASL115A-LSF [^]	RSK115A-KSS [^]	RVH115-HSF [^]	ARL115-LRA [^]	RPK115-HRZ [^]	TG115C-HQZ [^]	RQF115-FQS [^]	TG115C-JPZ [^]
105	○	○	○	○	○	○	○	○	○
102	TGH102-HVS [^]	ASL102A-LSF [^]	RSK102A-KSS [^]	RVH102-HSF [^]	ARL102-LRA [^]	RPK102-HRZ [^]	TG102C-HQZ [^]	RQF102-FQS [^]	TG102C-JPZ [^]
97	○	○	○	○	○	○	○	○	○
93	○	○	○	○	○	○	○	○	○
86	○	○	○	○	ARL86-LRA [^]	○	TG86C-HQZ [^]	RQF86-FQS [^]	○
76	○	○	○	○	○	○	○	○	○
I_r (A) Rated Current	15	30	25	15	30	15	15	10	20
U_r (VDC)[^] Rated Voltage	850		600		500		450		400
U_r (VAC)[*] Rated Voltage	○	○	○	○	○	○	○	○	○
Product Structure									
	Axial Shape		Radial Shape		Axial Shape	Radial Shape	Axial Shape	Radial Shape	Axial Shape

Direct Current Thermal-Link Alloy Type (DC-ATCO) Features & Model List Overview

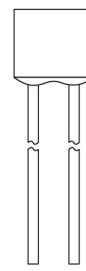
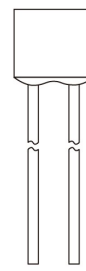
Rated Functioning Temp. (T_r) °C	Model											
	TG150C-JSZ*				HN150^*	HP150^*	HS150^*		QD150^	PD150^	TD150^	SD150^
230	○	○	○	○	○	○	○	○	○	○	○	○
221	○	○	○	○	○	○	○	○	○	○	○	○
205	○	○	○	○	○	○	○	○	○	○	○	○
200	○	○	○	○	○	○	○	○	○	○	○	○
187	○	○	○	○	○	○	○	○	○	○	○	○
160	○	○	○	○	○	○	○	○	○	○	○	○
150	TG150C-JSZ*	○	○	○	HN150^*	HP150^*	HS150^*	○	QD150^	PD150^	TD150^	SD150^
145	○	○	○	○	○	○	○	○	○	○	○	○
139	○	○	○	○	○	○	○	○	○	○	○	○
136	TG136C-JSZ*	○	○	○	HN136^*	HP136^*	HS136^*	○	QD136^	PD136^	TD136^	SD136^
135	○	○	○	○	○	○	○	○	○	○	○	○
133	○	○	○	○	○	○	○	○	○	○	○	○
130	○	○	○	○	○	○	○	○	QD130^	PD130^	TD130^	SD130^
125	TG125C-JSZ*	○	○	○	HN125^*	HP125^*	HS125^*	ALP125-PLZ^	QD125^	PD125^	TD125^	SD125^
123	○	○	○	○	○	○	○	○	○	○	○	○
120	○	○	○	○	○	○	○	○	○	○	○	○
115	TG115C-JSZ*	○	○	ALP115-HLZ^	○	○	○	○	QD115^	PD115^	TD115^	SD115^
105	○	○	○	○	○	○	○	○	○	○	○	○
102	TG102C-JSZ*	○	○	○	○	○	○	ALP102-PLZ^	QD102^	PD102^	TD102^	SD102^
97	○	○	○	○	○	○	○	○	○	○	○	○
93	○	○	○	○	○	○	○	○	○	○	○	○
86	○	TG86C-HSZ*	RPF86-FPF^	○	○	○	○	○	○	○	○	○
76	○	○	○	○	○	○	○	○	○	○	○	○
I_r (A) Rated Current	20	15	10	15	15	10	5	60	20	15 16	10	25
U_r (VDC)^ Rated Voltage	○	○	400	○	200	○	○	180	○	○	125	○
U_r (VAC)^* Rated Voltage	600	○	○	○	690	500	○	○	○	○	○	○
Product Structure												
	Axial Shape	Radial Shape	Radial Shape	Radial Shape	Axial Shape	Radial Shape		Radial Shape				

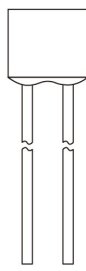
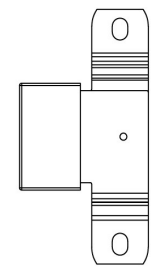
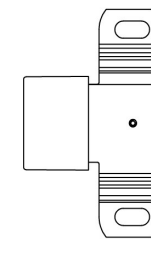
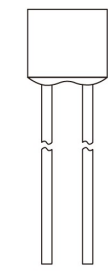
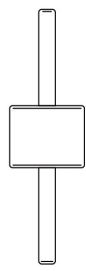

Direct Current Thermal-Link Alloy Type (DC-ATCO) Features & Model List Overview

Rated Functioning Temp. (T _r) °C	Model													
	Q136**	Q136*	Q136*	P136**	P136*	P136*	TB136-UHZ^	TB136-UJZ*	TS136-RHZ^	TS136-RJZ*	S136^	T136^	ADN230B-NEZ	
230	○	○	○	○	○	○	○	○	○	○	○	○	○	○
221	○	○	○	○	○	○	○	○	○	○	○	○	○	○
205	○	○	○	○	○	○	○	○	○	○	○	○	○	○
200	○	○	○	○	○	○	○	○	○	○	○	○	○	○
187	○	○	○	○	○	○	○	○	○	○	○	○	○	○
160	○	○	○	○	○	○	○	○	○	○	○	○	○	○
150	○	○	○	○	○	○	○	○	○	○	S150^	T150^	○	○
145	○	○	○	○	○	○	○	○	○	○	○	○	○	○
139	○	○	○	○	○	○	○	○	○	○	○	○	○	○
136	○	○	○	○	○	○	○	○	○	○	○	○	○	○
135	○	○	○	○	○	○	○	○	○	○	○	○	○	○
133	○	○	○	○	○	○	○	○	○	○	○	○	○	○
130	○	○	○	○	○	○	○	○	○	○	○	○	○	○
125	○	○	○	○	○	○	○	○	○	○	○	○	○	○
125	Q125**	○	○	P125**	○	○	TB125-UHZ^	TB125-UJZ*	TS125-RHZ^	TS125-RJZ*	○	○	○	○
123	○	○	○	○	○	○	○	○	○	○	○	○	○	○
120	○	○	○	○	○	○	○	○	○	○	○	○	○	○
115	Q115**	Q115*	Q115*	P115**	P115*	P115*	TB115-UHZ^	TB115-UJZ*	TS115-RHZ^	TS115-RJZ*	S115^	T115^	○	○
105	○	○	○	○	○	○	○	○	○	○	○	○	○	○
102	Q102**	○	○	P102**	P102*	P102*	TB102-UHZ^	TB102-UJZ*	TS102-RHZ^	TS102-RJZ*	S102^	T102^	○	○
97	○	○	○	○	○	○	○	○	○	○	○	○	○	○
93	○	○	○	○	○	○	○	○	○	○	○	○	○	○
86	○	○	○	○	○	○	○	○	○	○	○	○	○	○
76	○	○	○	○	○	○	○	○	○	○	○	○	○	○
I_r (A) Rated Current	25			20			200		100		10	15 16	50	
U_r (VDC)^ Rated Voltage	120						100	○	100	○	100	60		
U_r (VAC)* Rated Voltage	400	300	250	400	300	250	○	125	○	125	○	○		
Product Structure														
							Radial Shape						Axial Shape	

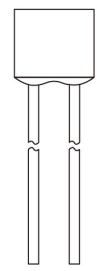
Direct Current Thermal-Link Alloy Type (DC-ATCO) Features & Model List Overview

Rated Functioning Temp. (T _r) °C	Model																																
	R31^*	U31^*						C31^*				B31^*	H31^*	V31^*	V31^*		X31^*	K31^*															
230	○	○	○	○	○	○	○	○	○	○	○	○	○	○	○	○	○	○	○	○													
221	R31^*	○	U31^*	○	○	○	○	○	○	○	○	○	B31^*	○	H31^*	V31^*	V31^*	○	○	X31^*	K31^*	○											
205	R32^*	○	U32^*	○	○	○	○	○	○	○	○	○	B32^*	○	H32^*	V32^*	V32^*	○	○	X32^*	K32^*	○											
200	○	○	○	○	○	○	○	○	○	○	○	○	○	○	○	○	○	○	○	○	○	○											
187	○	○	○	○	○	○	○	○	○	○	○	○	○	○	○	○	○	○	○	X17^*	K17^*	○											
160	R16^*	○	U16^*	○	○	○	○	○	○	○	○	○	○	○	H16^*	V16^*	○	○	○	X16^*	K16^*	F16^*											
150	R7^*	○	U7^*	○	○	○	○	○	○	○	○	○	○	○	○	○	○	○	○	X7^*	K7^*	F7^*											
145	R6^*	○	U6^*	C6^*	○	○	○	○	○	○	○	○	○	○	○	○	○	K6^*	F6^*	X6^*	K6^*	F6^*											
139	○	CR13^*	○	○	M13^*	C13^*	○	○	○	SF13^*	V13^*	○	○	○	○	○	○	○	F13^*	○	○	F13^*											
136	○	○	○	○	○	○	○	○	○	○	○	○	○	○	○	○	○	○	K9^*	○	X9^*	K9^*	○										
135	R5^*	○	U5^*	○	○	○	○	○	○	○	○	○	○	○	○	○	○	○	○	X5^*	K5^*	○											
133	○	○	○	○	○	○	○	○	○	○	V8^*	SF8^*	○	○	○	○	○	○	○	F8^*	X8^*	K8^*	F8^*										
130	R4^*	○	U4^*	○	○	○	○	○	○	○	V4^*	SF4^*	○	○	○	○	○	○	○	F4^*	X4^*	K4^*	F4^*										
125	R3^*	○	U3^*	○	○	○	○	○	○	○	○	○	○	○	H3^*	○	○	○	○	X3^*	K3^*	F3^*											
123	○	○	○	○	○	○	○	○	○	○	○	○	○	○	○	○	○	○	○	○	○	○											
120	○	○	○	○	○	○	○	○	○	○	○	○	○	○	○	○	○	○	○	○	○	○											
115	R2^*	○	U2^*	○	○	○	C2^*	○	○	○	V2^*	SF2^*	○	○	○	○	○	○	○	F2^*	X2^*	K2^*	F2^*										
105	○	○	○	○	○	○	○	○	○	○	○	○	○	○	○	○	○	○	○	○	○	○											
102	R1^*	○	U1^*	○	○	○	○	○	○	○	○	○	○	○	○	○	○	○	○	F1^*	X1^*	K1^*	F1^*										
97	○	○	○	○	○	○	○	○	○	○	○	○	○	○	○	○	○	○	○	○	○	○											
93	○	○	○	○	○	○	○	○	○	○	○	○	○	○	○	○	○	○	○	○	○	○											
86	R18^*	○	U18^*	○	○	○	C18^*	○	○	○	○	○	○	V18^*	○	○	○	○	○	F18^*	X18^*	K18^*	F18^*										
76	R0^*	○	U0^*	○	○	○	○	○	○	○	○	○	○	○	○	○	○	○	○	X0^*	K0^*	F0^*											
I_r (A) Rated Current		15		10		9		8.5		8		6		5		4		3		2.5		2		1		4		3		2		1	
U_r (VDC)^* Rated Voltage		60																															
U_r (VAC)^* Rated Voltage		250		250		○		○		250		○		250		○		250		125		○		250		○		○		○			
Product Structure		 <p>Axial Shape</p>												 <p>Radial Shape</p>																			

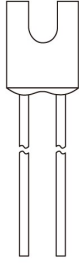
Direct Current Thermal-Link Alloy Type (DC-ATCO) Features & Model List Overview

Rated Functioning Temp. (T _r) °C	Model										ADN230B-NDZ ^Δ		ADN230B-PDZ ^Δ		ADN230B-QBZ ^Δ	
	XG31*	KG31*			C31*		B31*		H31*					ADN205B-NDZ ^Δ		
230	○	○	○	○	○	○	○	○	○	○	○	○	○	○	○	
221	XG31*	KG31*	○	○	C31*	○	B31*	○	H31*	○	○	○	○	ADN205B-NDZ ^Δ	○	
205	XG32*	KG32*	○	○	C33*	○	B32*	○	H32*	○	○	○	○	○	○	
200	○	○	○	○	○	○	○	○	○	○	○	○	○	○	○	
187	○	○	○	○	○	○	○	○	○	○	○	○	○	○	○	
160	XG16*	KG16*	○	○	○	B16*	○	○	○	○	○	○	○	○	○	
150	XG7*	KG7*	C7 ^Δ	C7*	○	B7 ^Δ	○	H7 ^Δ	○	V7 ^Δ	○	○	○	○	○	
145	XG6*	KG6*	C6 ^Δ	C6*	○	B6 ^Δ	○	H6 ^Δ	○	V6 ^Δ	○	○	○	○	○	
139	○	○	C13 ^Δ	C13*	○	B13 ^Δ	○	H13 ^Δ	○	V13 ^Δ	○	○	○	○	○	
136	XG9*	KG9*	C9 ^Δ	C9*	○	B9 ^Δ	○	H9 ^Δ	○	V9 ^Δ	○	○	○	○	○	
135	XG5*	KG5*	C5 ^Δ	C5*	○	B5 ^Δ	○	H5 ^Δ	○	V5 ^Δ	○	○	○	○	○	
133	XG8*	KG8*	C8 ^Δ	C8*	○	B8 ^Δ	○	H8 ^Δ	○	V8 ^Δ	○	○	○	○	○	
130	XG4*	KG4*	C4 ^Δ	C4*	○	B4 ^Δ	○	H4 ^Δ	○	V4 ^Δ	○	○	○	○	○	
125	XG3 ^Δ *	KG3 ^Δ *	C3 ^Δ	C3*	○	B3 ^Δ *	○	○	○	V3 ^Δ *	○	○	○	○	○	
123	○	○	○	○	○	○	○	○	○	○	○	○	○	○	○	
120	○	○	○	○	○	○	○	○	○	○	○	○	○	○	○	
115	XG2 ^Δ *	KG2 ^Δ *	C2 ^Δ	C2*	○	B2 ^Δ *	○	H2 ^Δ *	○	V2 ^Δ *	○	○	○	○	○	
105	○	○	○	○	○	○	○	○	○	○	○	○	○	○	○	
102	XG1 ^Δ *	KG1 ^Δ *	○	C1 ^Δ *	C1*	B1 ^Δ *	B1*	H1 ^Δ *	H1*	V1 ^Δ *	V1*	○	○	○	○	
97	○	○	○	○	C21 ^Δ *	○	B21 ^Δ *	○	H21 ^Δ *	○	V21 ^Δ *	○	○	○	○	
93	○	○	○	○	○	○	○	○	○	○	○	○	○	○	○	
86	XG18 ^Δ *	KG18 ^Δ *	○	C18 ^Δ *	C18*	B18 ^Δ *	B18*	H18 ^Δ *	H18*	V18 ^Δ *	V18*	○	○	○	○	
76	XG0*	KG0*	○	C0*	○	B0 ^Δ *	B0*	H0 ^Δ *	H0*	V0 ^Δ *	V0*	○	○	○	○	
I_r (A) Rated Current	3	2	7	5	3	2	1	50	55	50	80					
U_r (VDC)^Δ Rated Voltage	60		50										49	48	24	
U_r (VAC)[*] Rated Voltage	250		○	250	125	250	125	250	125	250	125	○				
Product Structure	 Radial Shape					 Axial Shape					